

## PTSA 0,5/13-2,5-Z

Order No.: 1990119

The figure shows a 10-position version of the product

<http://eshop.phoenixcontact.de/phoenix/treeViewClick.do?UID=1990119>Pcb terminal, number of poles: 13, pitch: 2.5 mm, U = 160 V, I = 2 A,  
cross section: 0.5 mm<sup>2</sup>

### Commercial data

EAN	4017918973681
Pack	50 Pcs.
Customs tariff	85369010
Weight/Piece	0.0052 KG
Catalog page information	Page 407 (CC-2007)

### Product notes

WEEE/RoHS-compliant since:  
01/29/2004

<http://www.download.phoenixcontact.com>  
Please note that the data given here has been taken from the online catalog. For comprehensive information and data, please refer to the user documentation. The General Terms and Conditions of Use apply to Internet downloads.

### Technical data

#### Dimensions / positions

Pitch	2.5 mm
Number of positions	13
Pin dimensions	0,4 x 0,75
Pin spacing	2.5 mm

**Technical data**

Rated surge voltage (III/3)	2.5 kV
Rated surge voltage (III/2)	2.5 kV
Rated surge voltage (II/2)	2.5 kV
Rated voltage (III/2)	250 V
Rated voltage (II/2)	250 V
Connection in acc. with standard	EN-VDE
Nominal current $I_N$	2 A
Nominal voltage $U_N$	160 V
Nominal cross section	0.5 mm <sup>2</sup>
Maximum load current	2 A
Stripping length	8 mm

**Connection data**

Conductor cross section solid min.	0.14 mm <sup>2</sup>
Conductor cross section solid max.	0.5 mm <sup>2</sup>
Conductor cross section stranded min.	0.2 mm <sup>2</sup>
Conductor cross section stranded max.	0.5 mm <sup>2</sup>
Conductor cross section AWG/kcmil min.	24
Conductor cross section AWG/kcmil max	20

**Certificates / Approvals**



**CUL**

Nominal voltage $U_N$	300 V
Nominal current $I_N$	2 A
AWG/kcmil	26-20

**UL**

Nominal voltage $U_N$	300 V
Nominal current $I_N$	2 A
AWG/kcmil	26-20
Certification	CCA, CUL, UL, VDE-PZI

## Drawings

### Drilling diagram

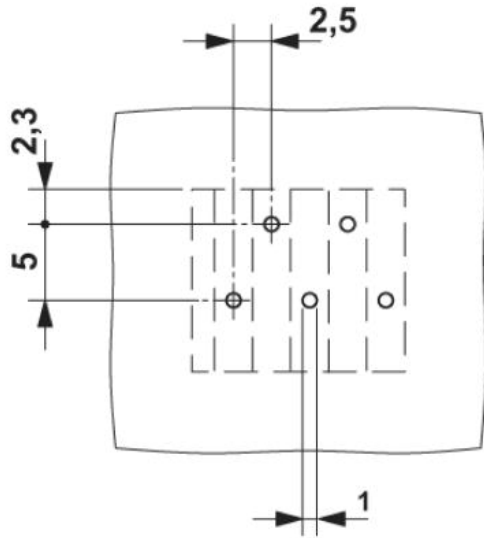

The illustration shows the 5-pos. version – Zig-zag pinning starts at the right-hand position. Other pinning available on request.

### Dimensioned drawing

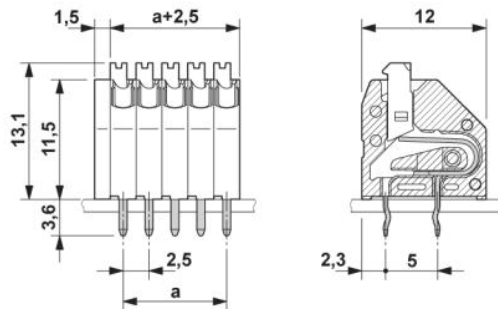

The illustration shows the 5-pos. version

**Address**

PHOENIX CONTACT Inc., USA  
586 Fulling Mill Road  
Middletown, PA 17057, USA  
Phone (800) 888-7388  
Fax (717) 944-1625  
<http://www.phoenixcon.com>



© 2008 Phoenix Contact  
Technical modifications reserved;